

# burda Download-Schnitt

Modell 115 Burda Style 01/2014

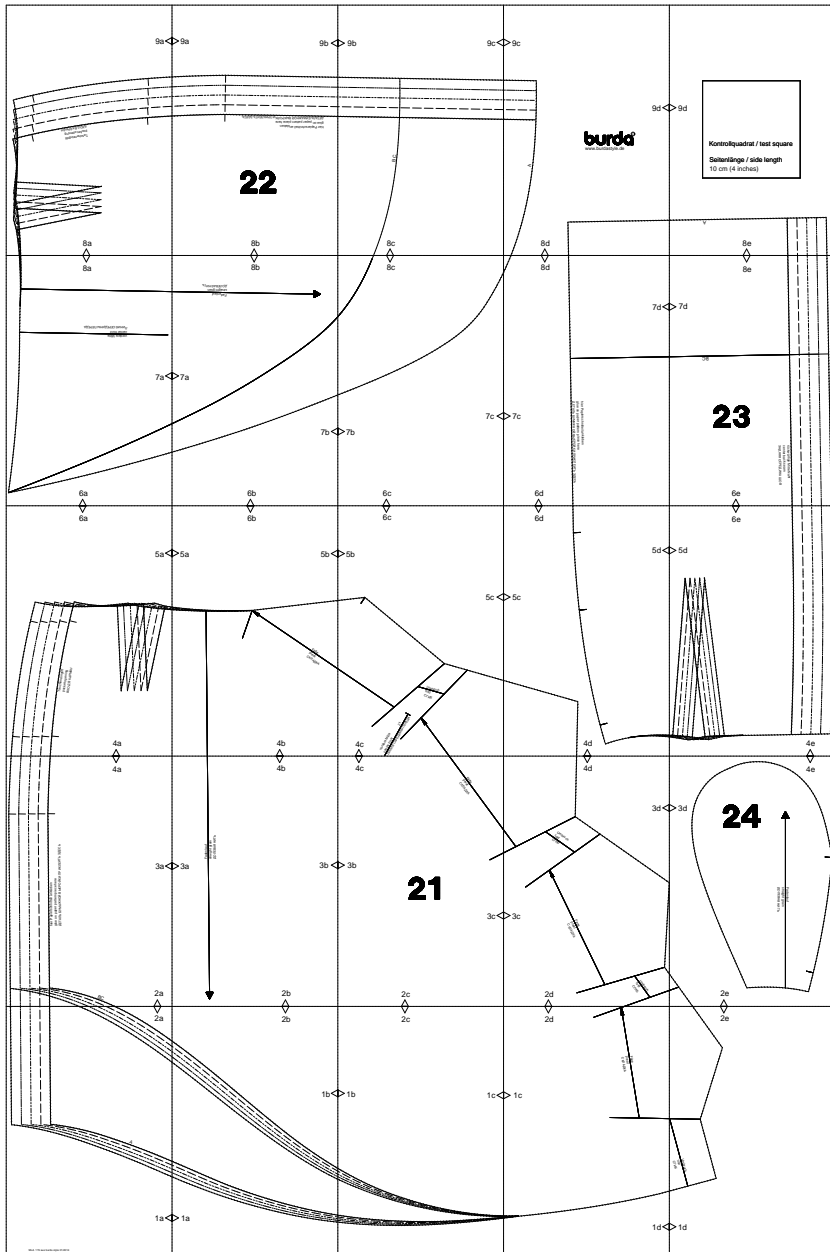

Copyright 2013 by Verlag Aenne Burda GmbH & Co. KG, Hubert-Burda Platz 2, D-77652 Offenburg

Sämtliche Modelle, Schnittteile und Zeichnungen stehen unter Urheberschutz, gewerbliches Nacharbeiten ist untersagt.

Der Verlag haftet nicht für Schäden, die durch unsachgemäße Handhabung des Schnitts, der Materialien, unsachgemäße Ausführung der Tipps und Anleitungen oder unsachgemäße Nutzung der Modelle entstehen.



2a

A

1a

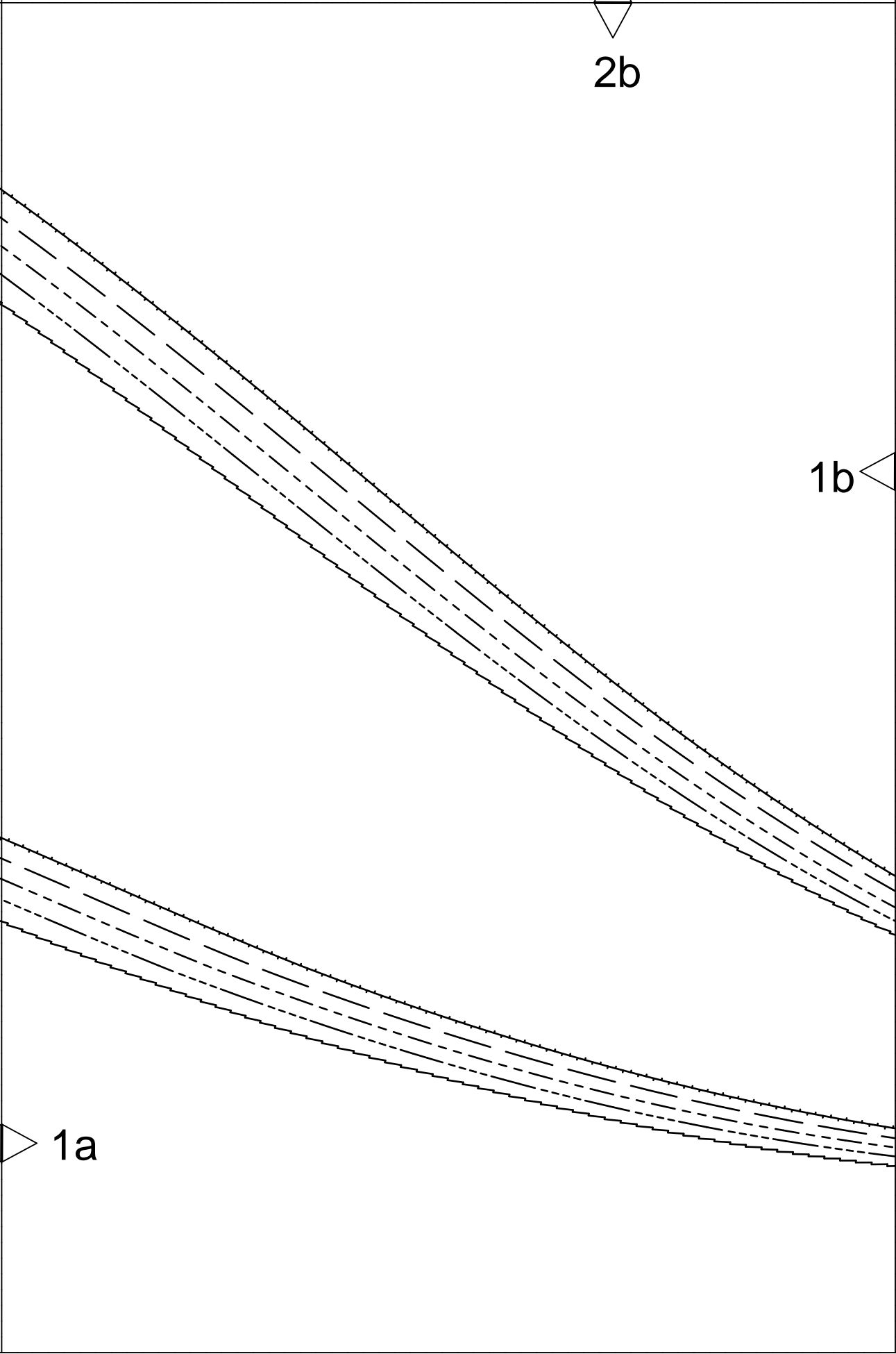

2b

1b

1a

2c

1b

1c

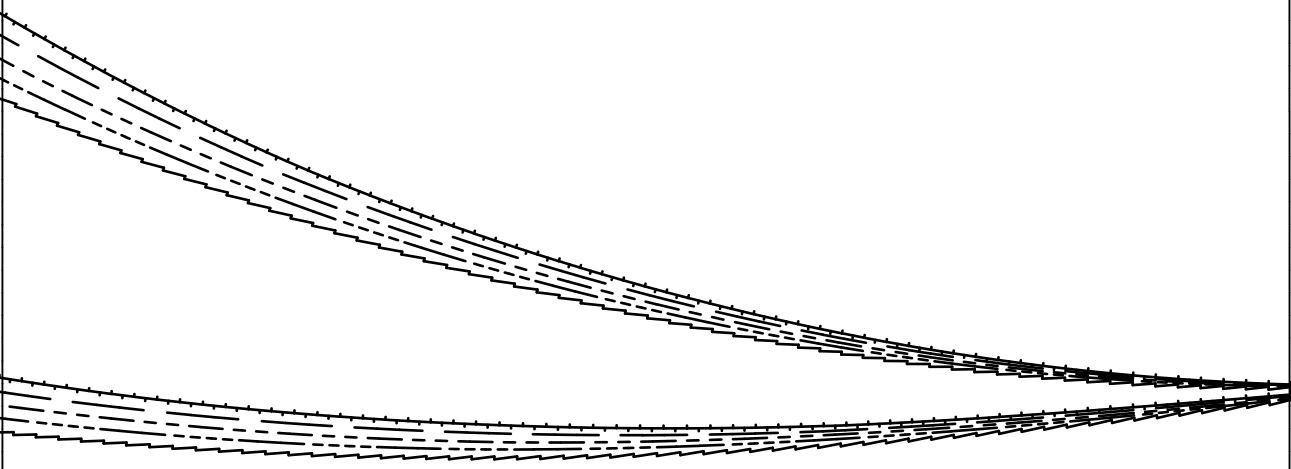

2d

1c

1d

Falte  
pleat  
СКОТЛДКА

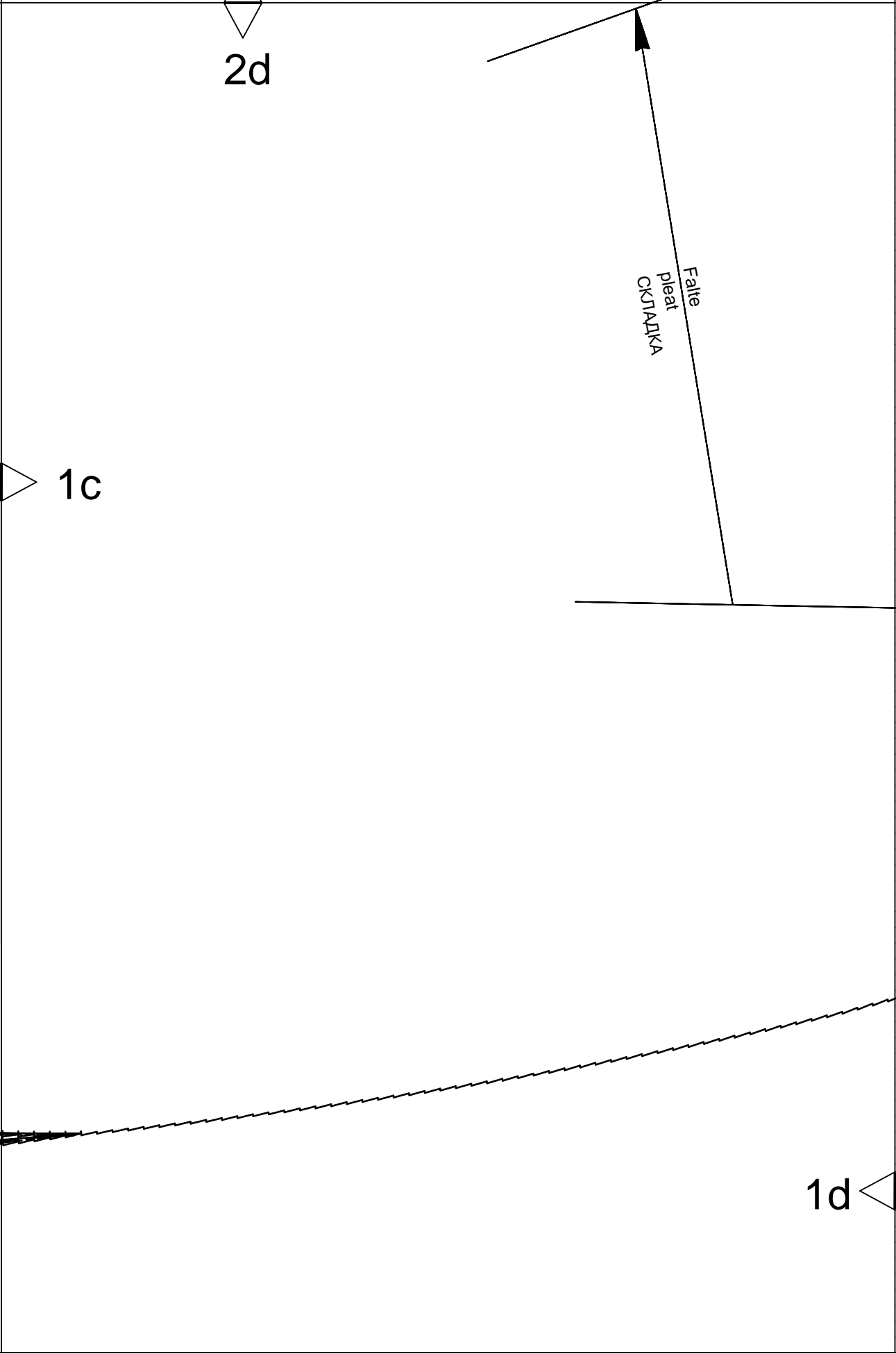

2e

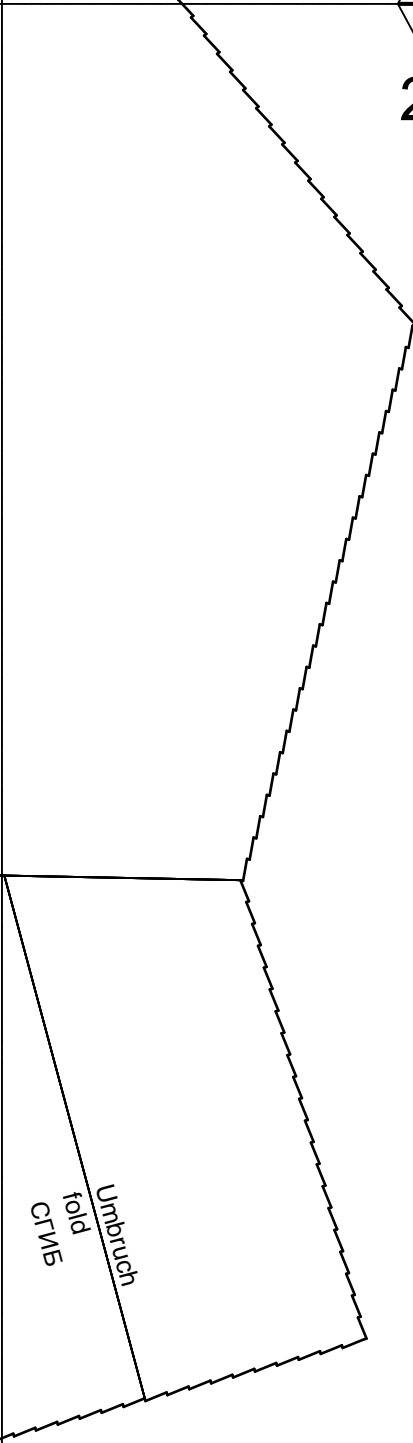

1d

4a

3a

hier Papierschnittteil ankleben  
glue on paper pattern piece here  
ДЕТАЛЬ БУМАЖНОЙ ВЫКРОЙКИ ПРИКЛЕИТЬ ЗДЕСЬ

2a

BC

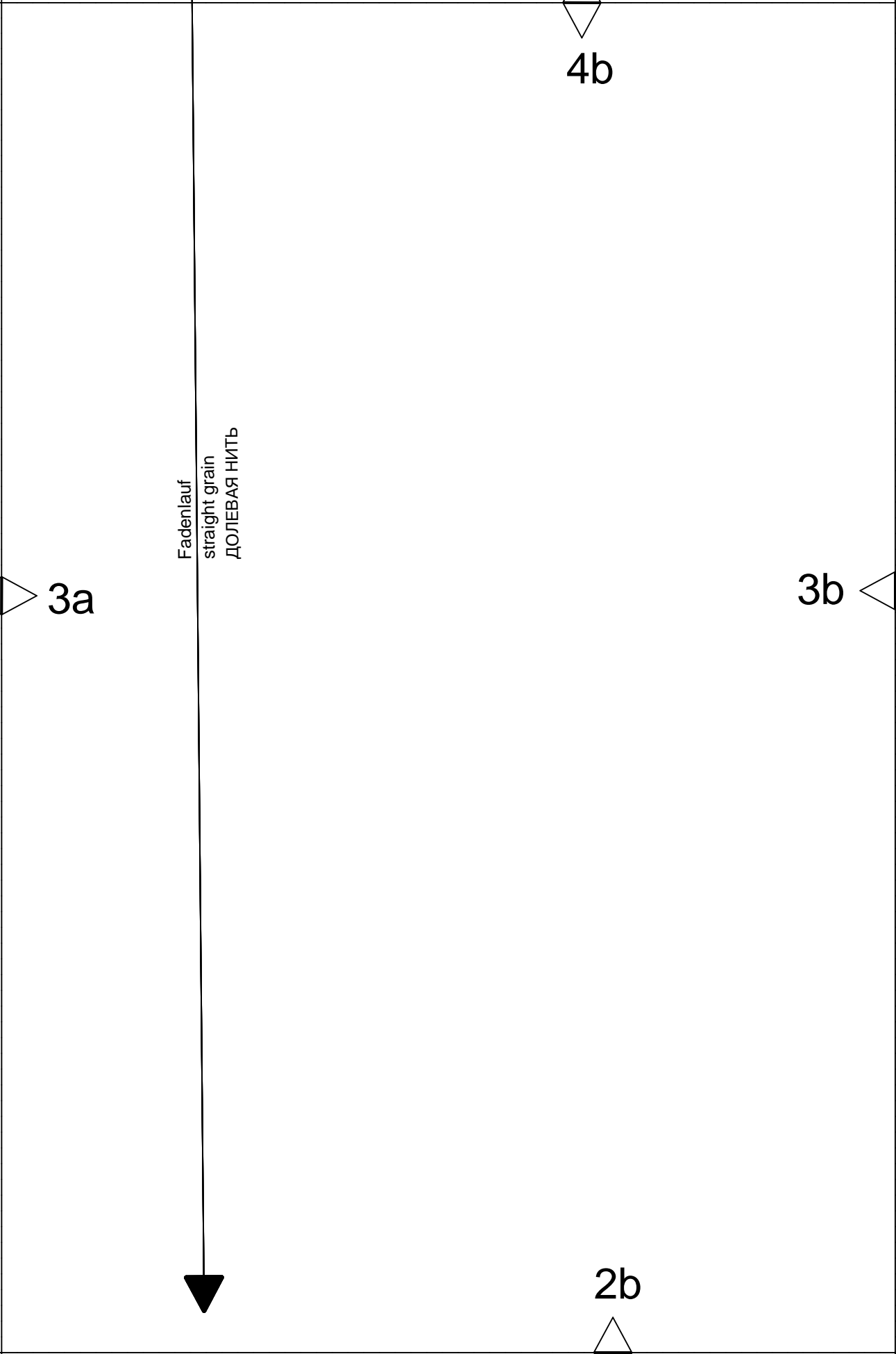



4c

Falte  
pleat  
СКЛАДКА

3b

21

3c

2c

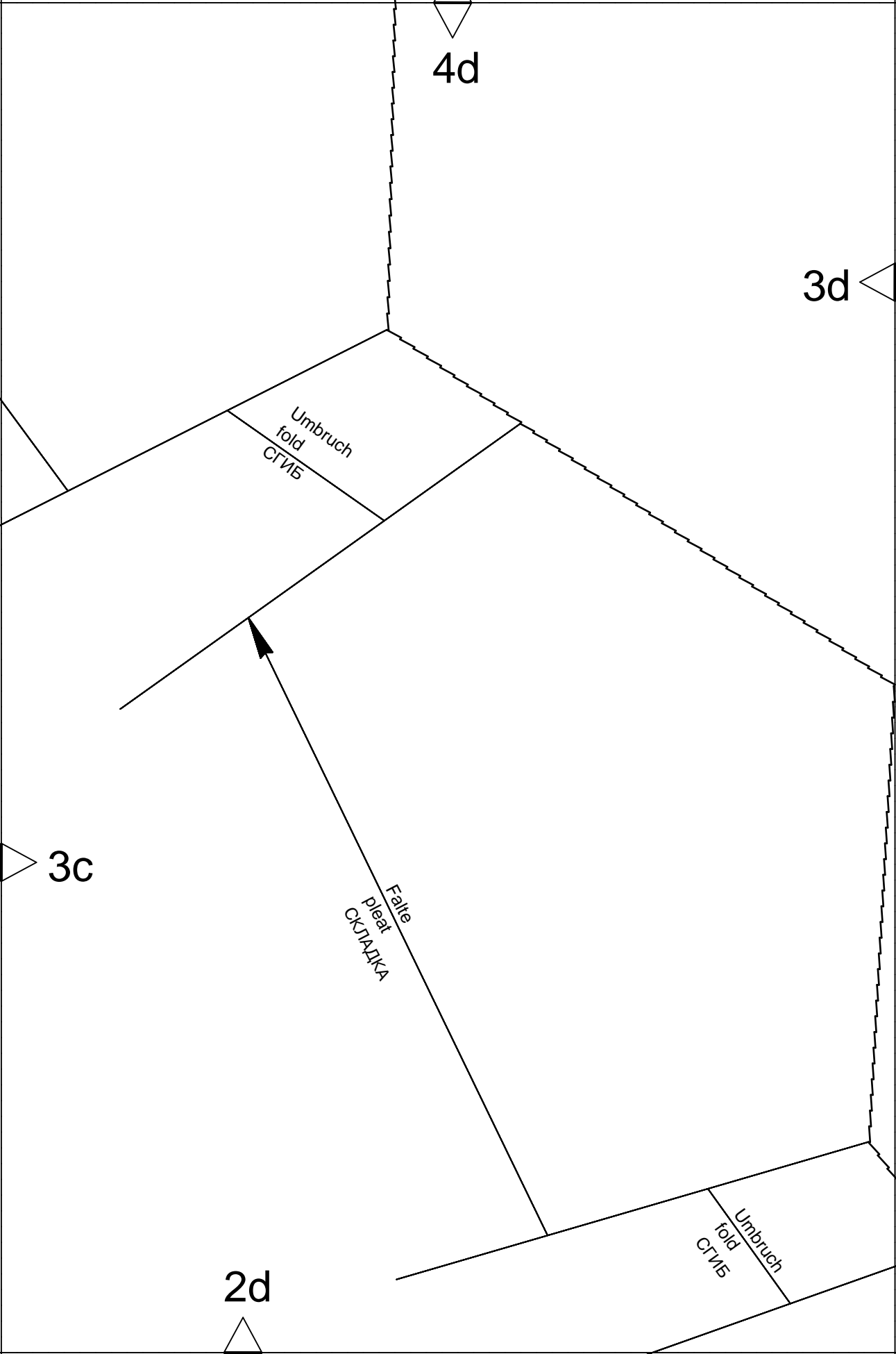

4d

3d

Umbruch  
fold  
СГИБ

3c

Falte  
pleat  
СКЛАДКА

Umbruch  
fold  
СГИБ

2d

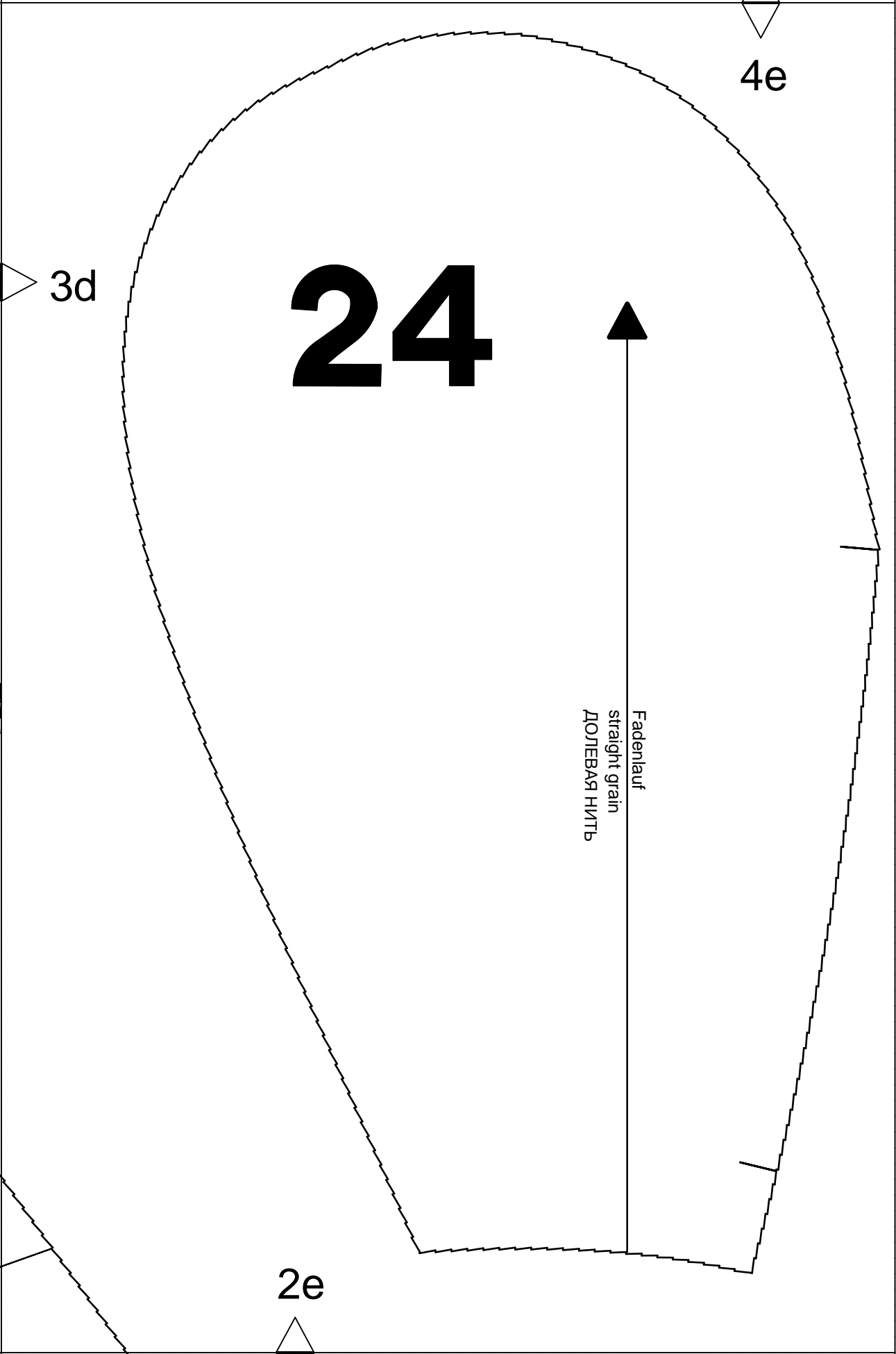

6a

5a

Tascheneingriff  
pocket opening  
ВХОД В КАРМАН

4a

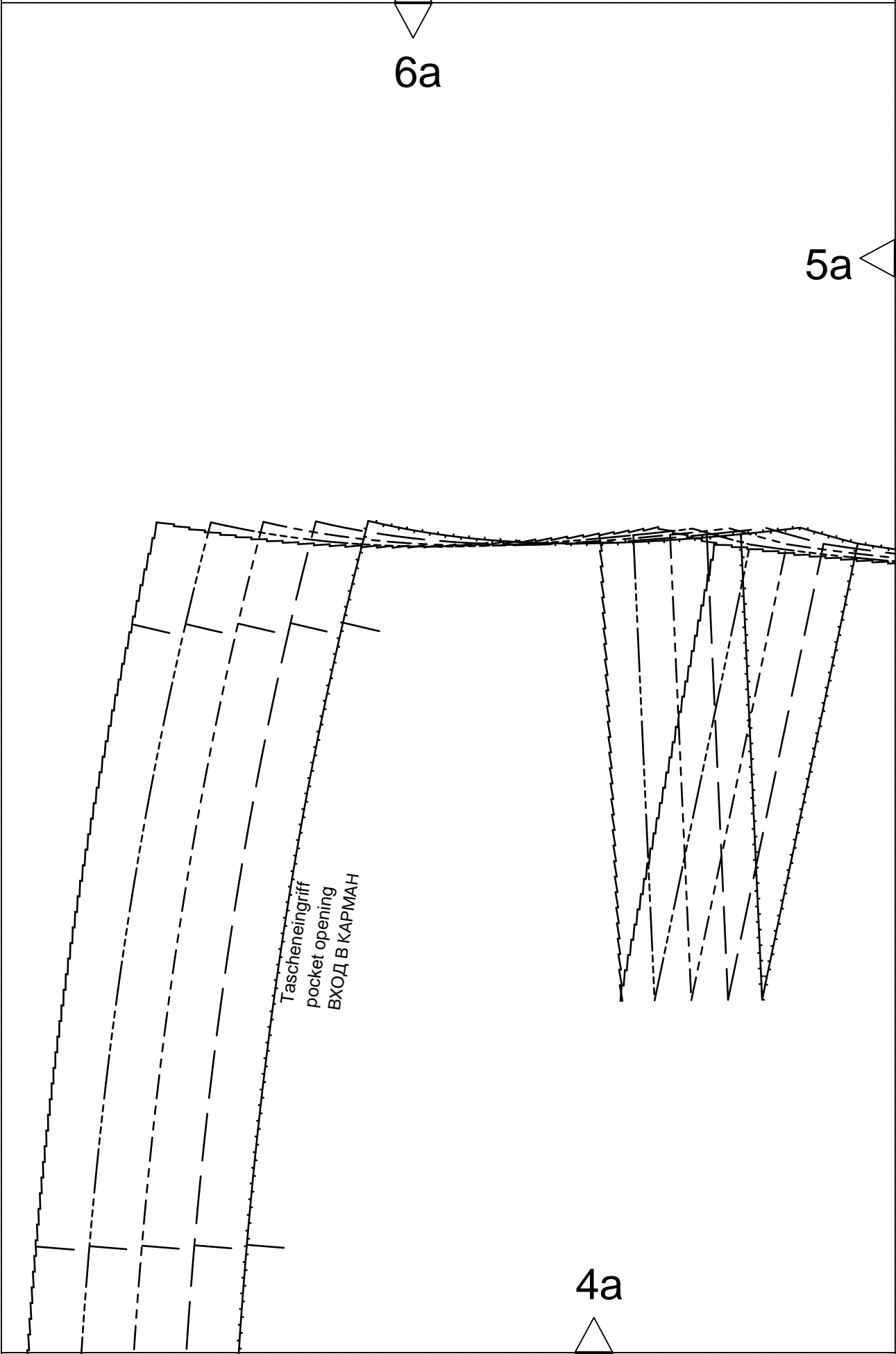

6b

5a

5b

Falte  
pleat  
СКЛАДКА

4b

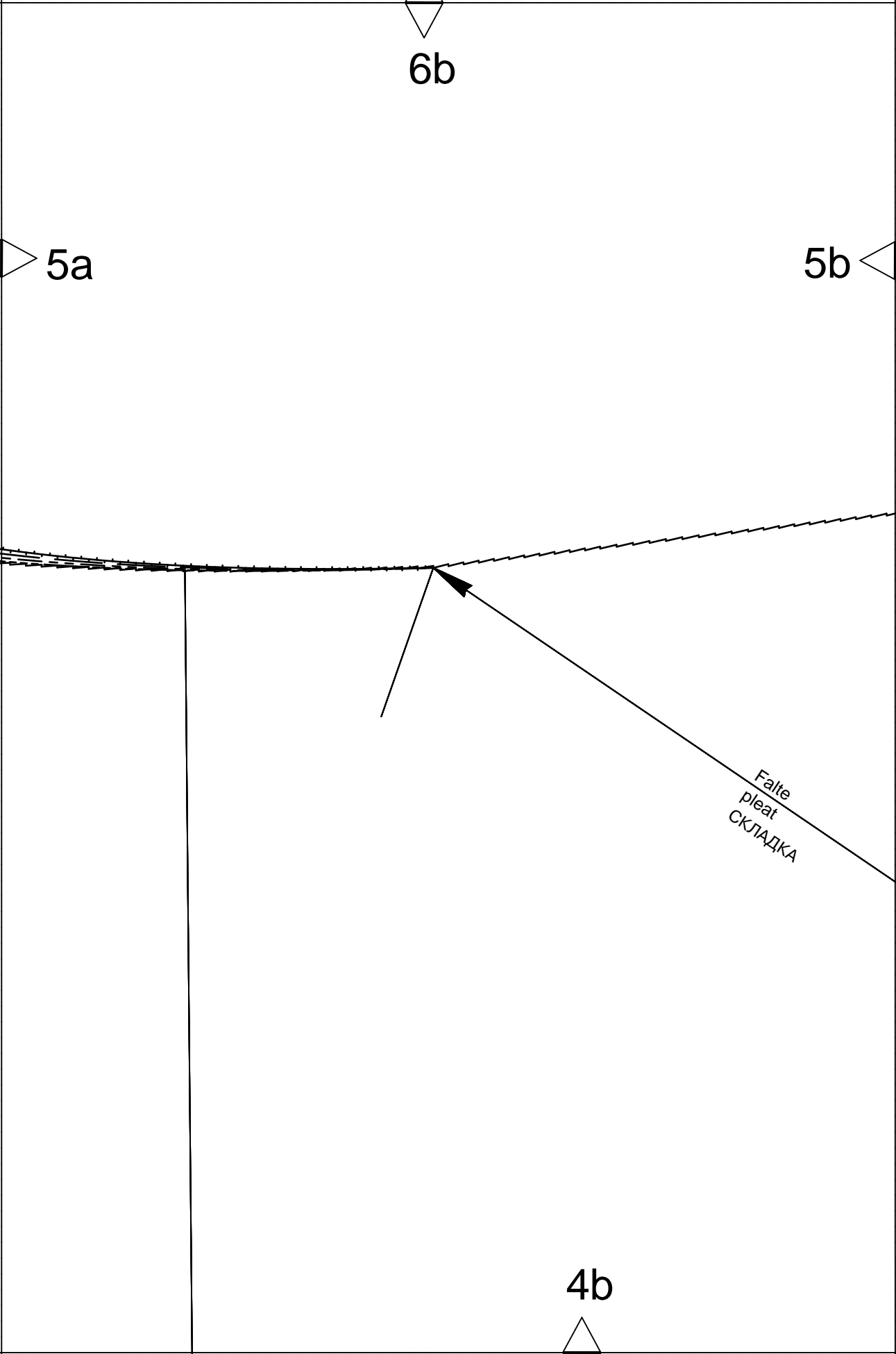

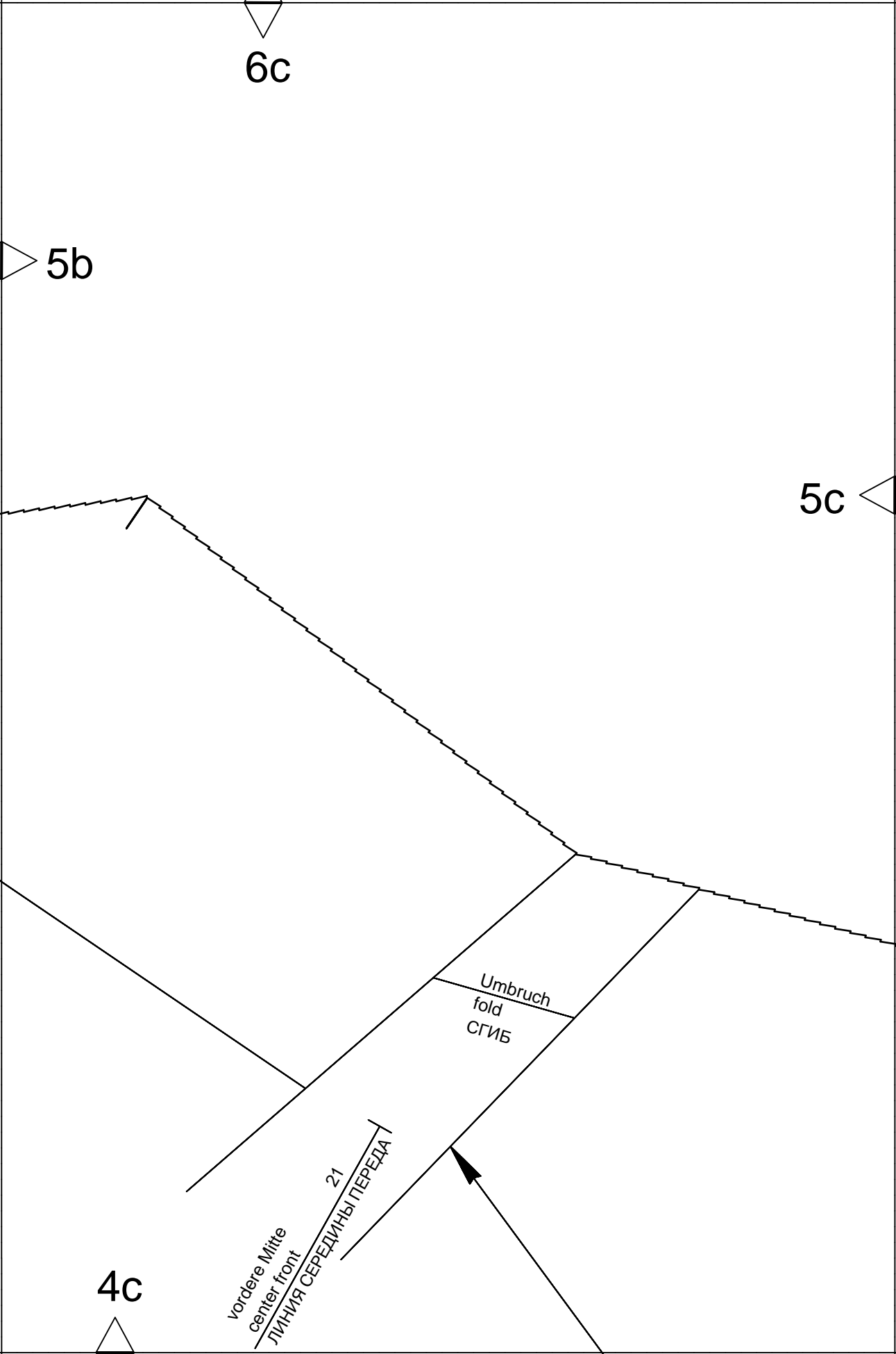

6c

5b

5c

4c

vordere Mitte  
center front  
ЛИНИЯ СЕРЕДИНЫ ПЕРЕДА

21

Umbruch  
fold  
СГИБ

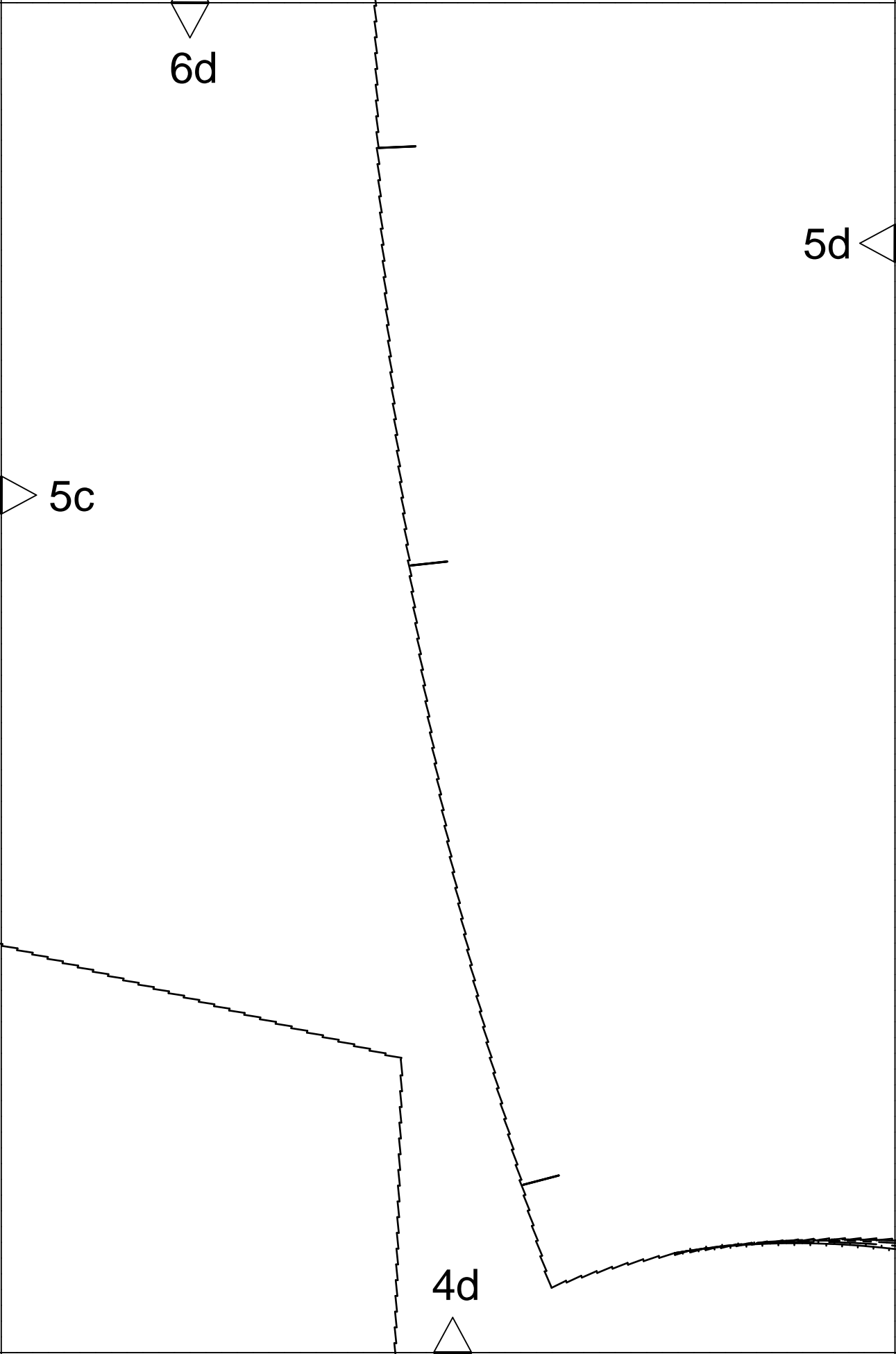

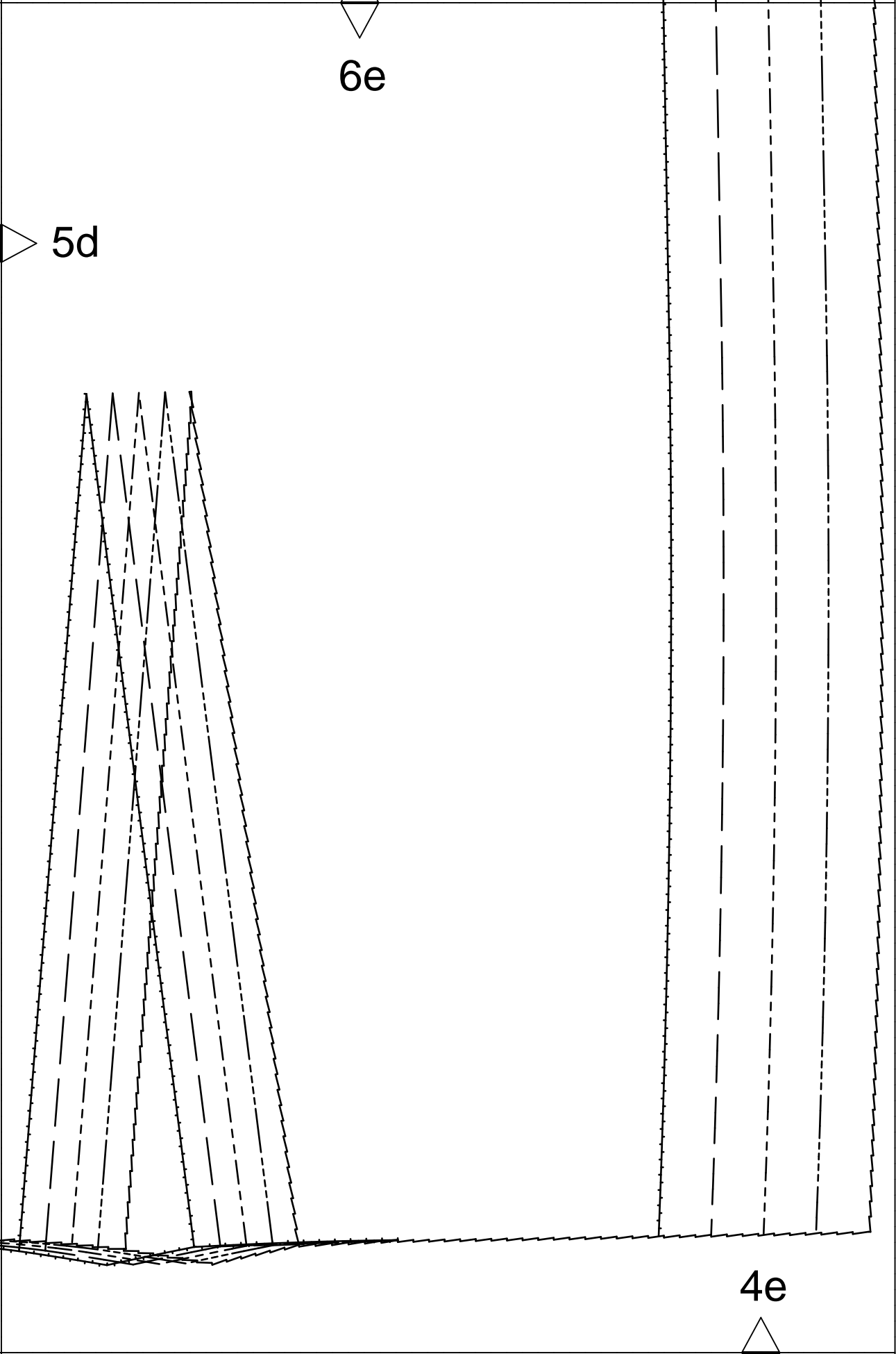



8a

ЛНИННЯ СЕРЕДНЬОПЕРЕДНА  
center front  
vordere Mitte

7a

6a

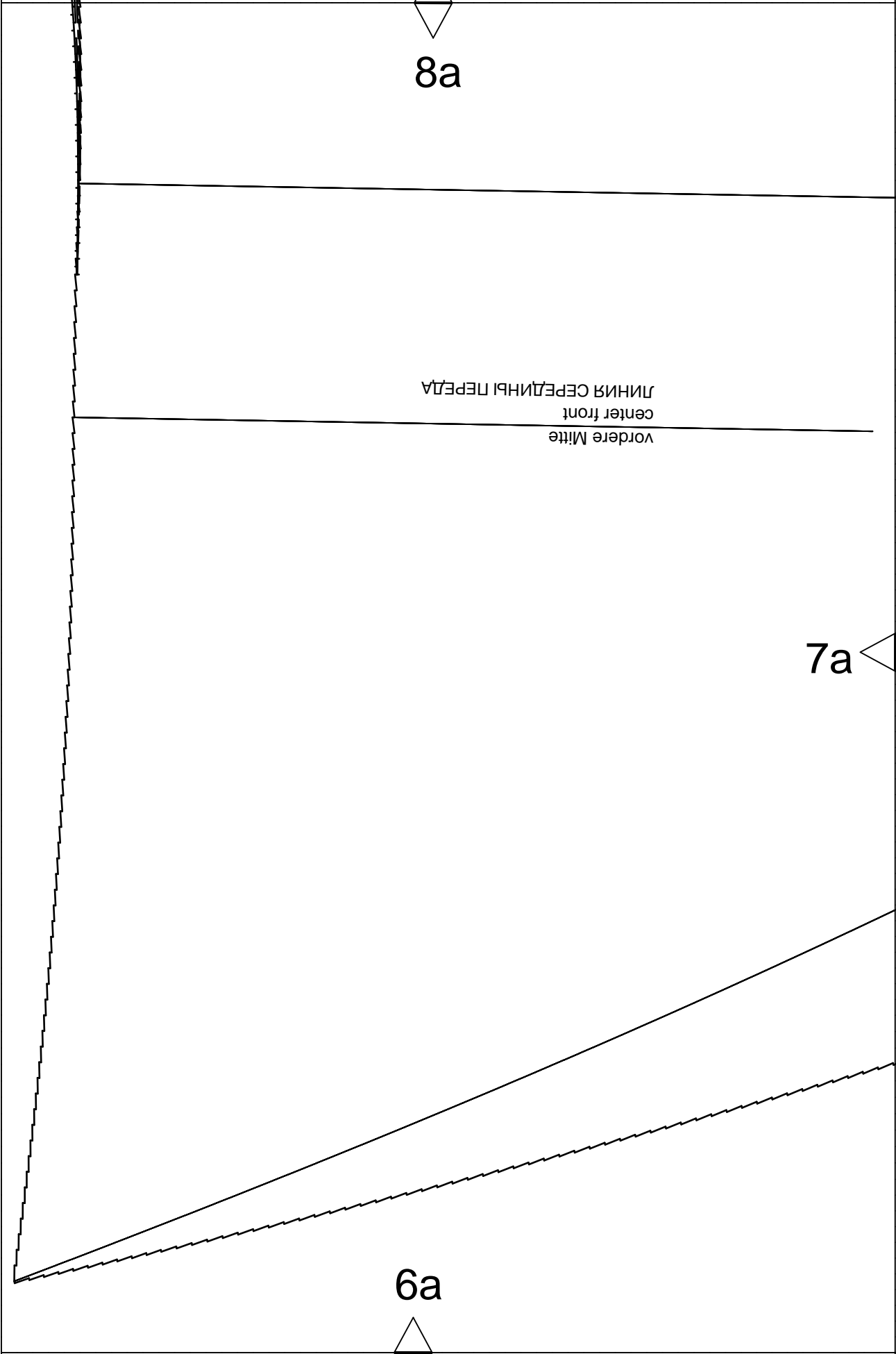

8b

Фаденлауф  
straight grain  
ДОЛБЕВАЯ НИТЬ

7a

7b

6b

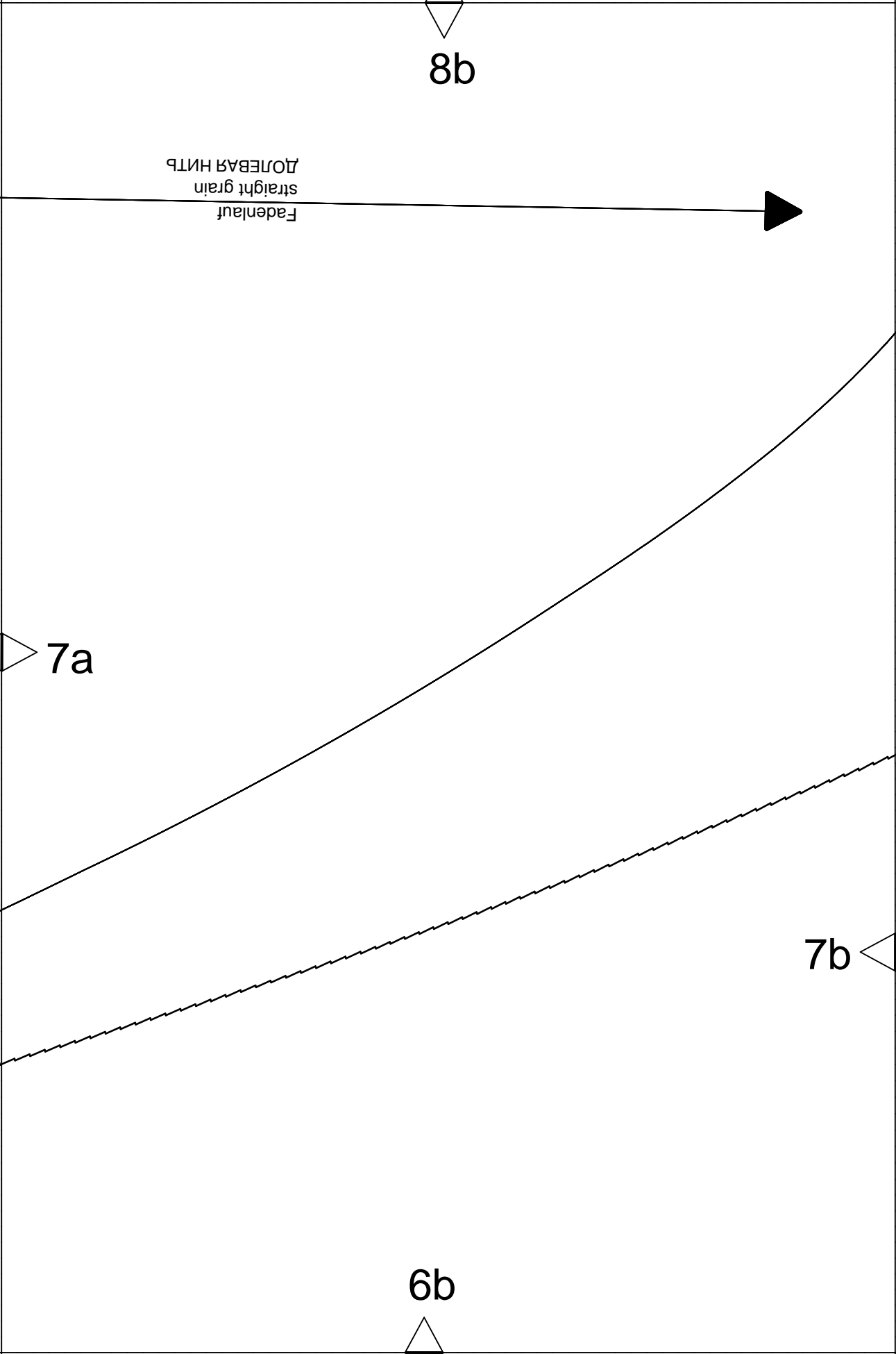

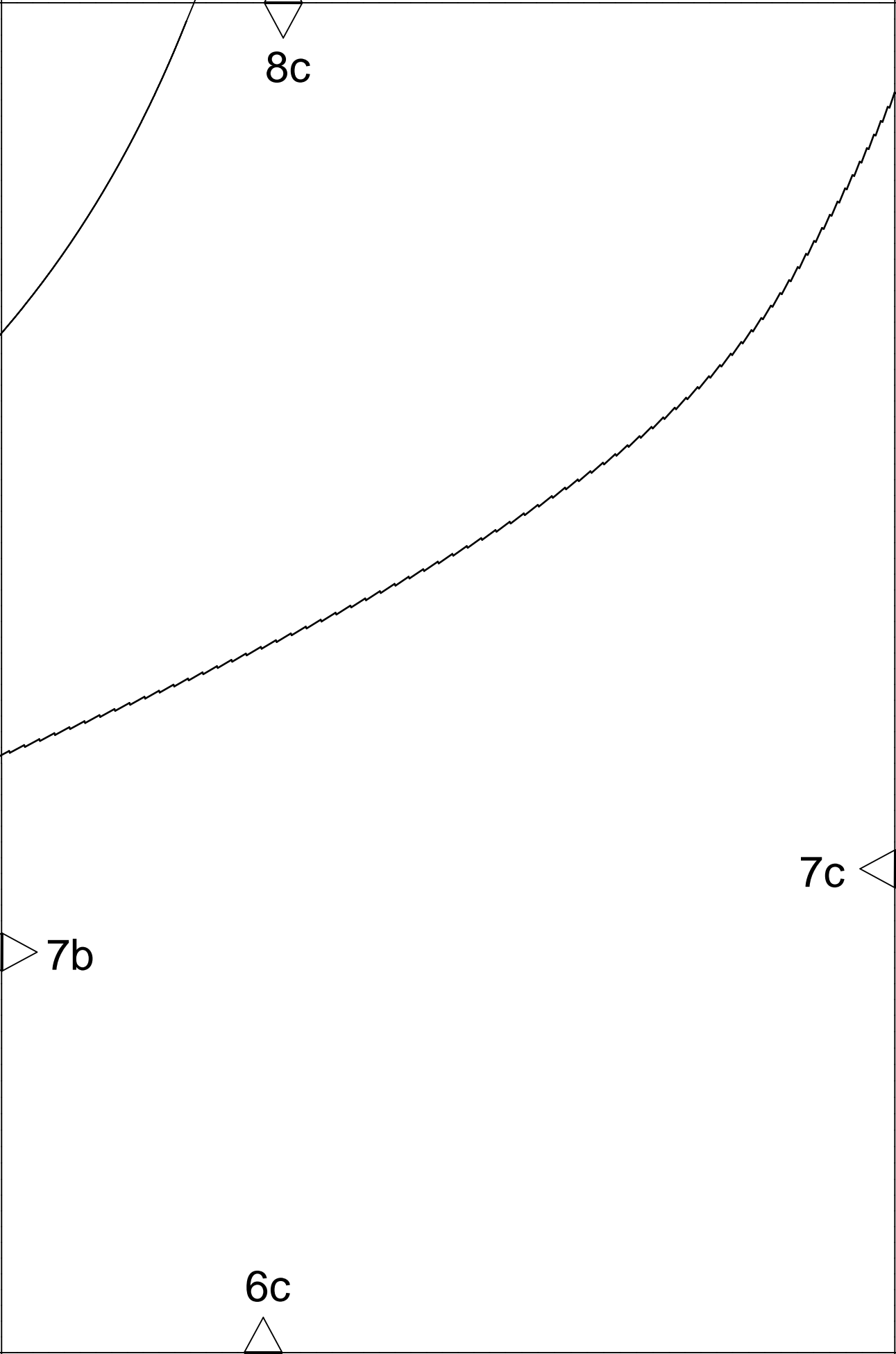

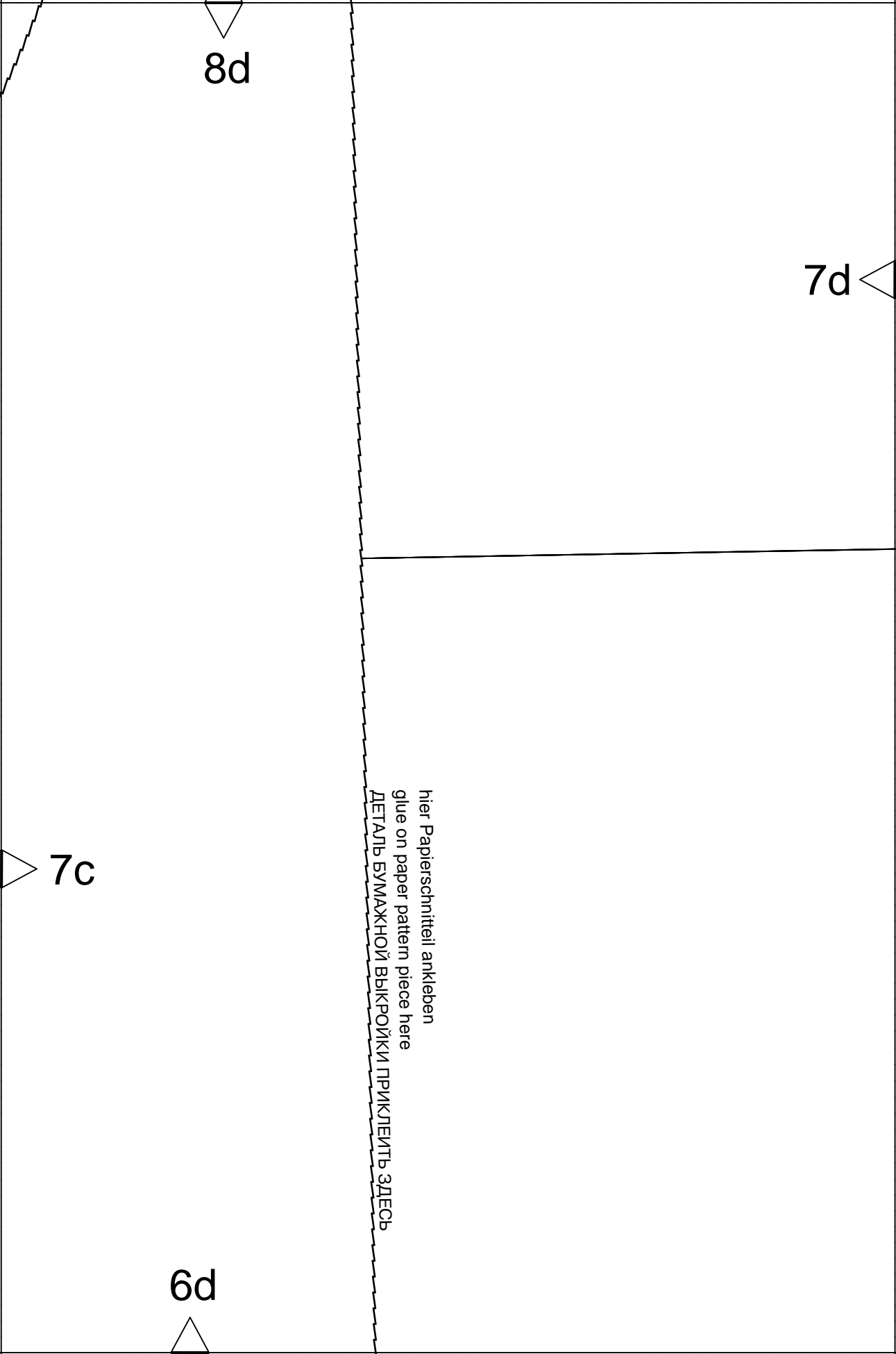

8d

7d

7c

6d

hier Papierschnittteil ankleben  
glue on paper pattern piece here  
ДЕТАЛЬ БУМАЖНОЙ ВЫКРОЙКИ ПРИКЛЕИТЬ ЗДЕСЬ

8e

7d

BC

23

rückwärtige Mitte Naht  
center back seam  
ЗАДНЯЯ СЕРЕДИНА ШОБ

6e

9a

Тascheneingriff  
pocket opening  
БХОД Б КАРМАН

8a

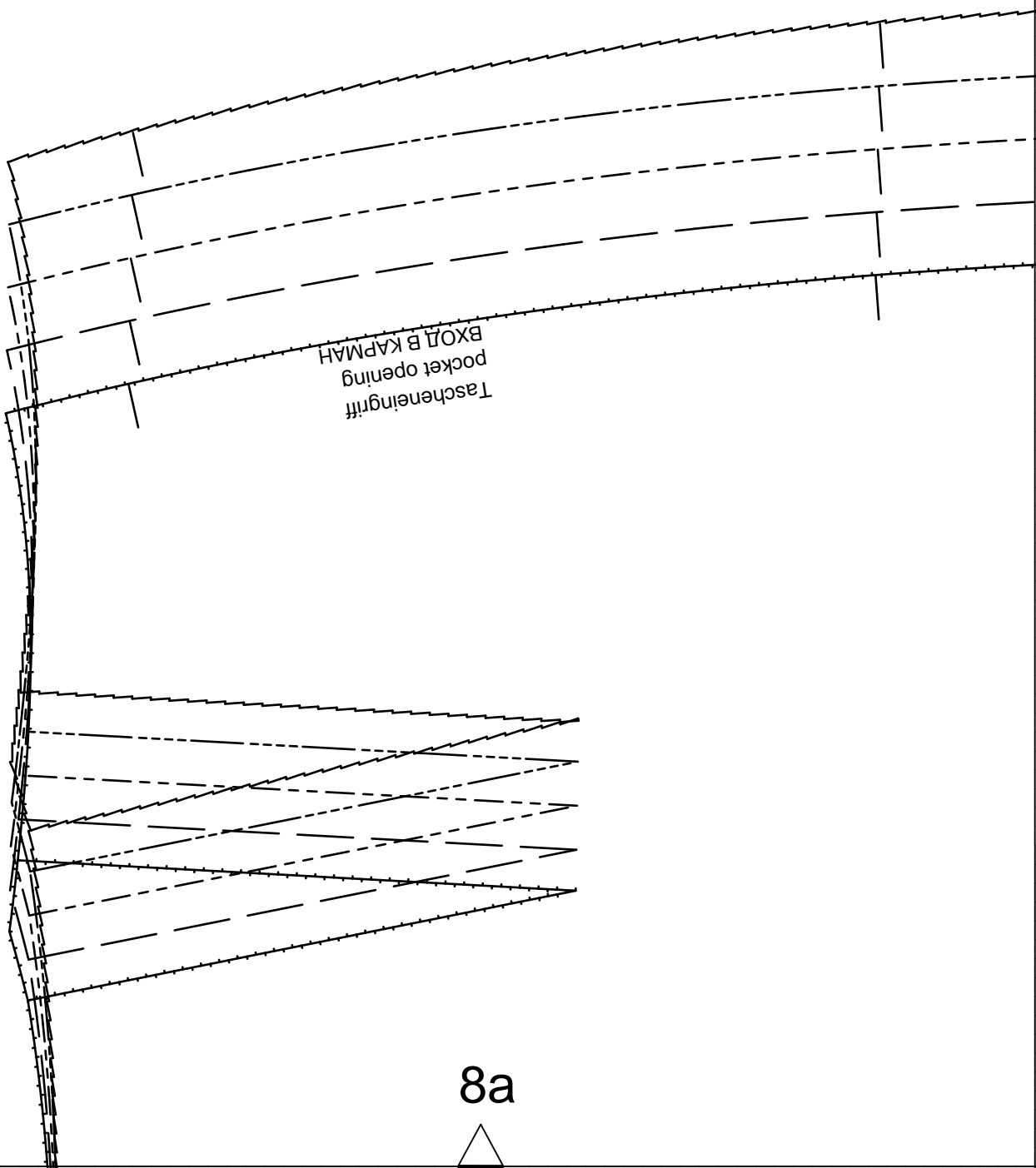

9a

9b

hier Papierschneitteil ankleben  
glue on paper pattern piece here  
ДЕТАЛЬ БУМАЖНОГО ВЫКРОЙКИ ПРИКЛЕИТЬ ЗДЕСЬ

22

8b

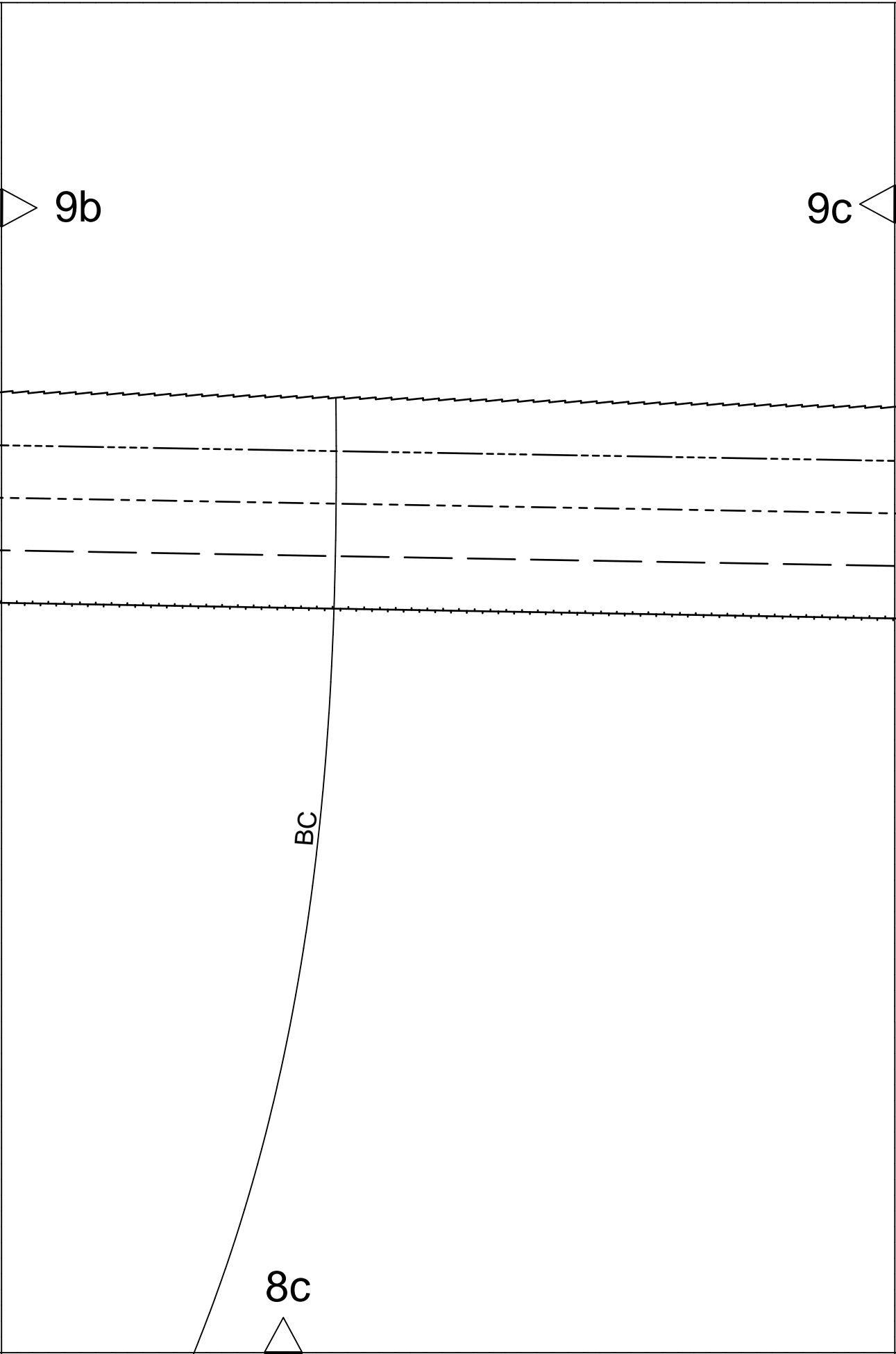

9b

9c

BC

8c



9c

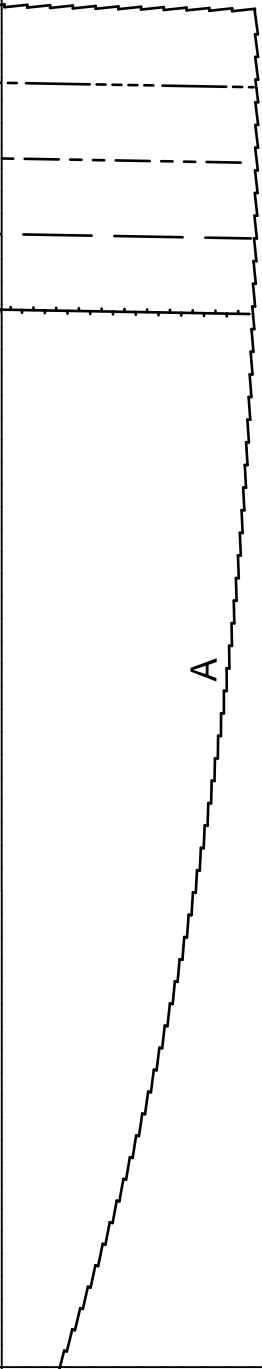

9d

**burda**<sup>®</sup>

[www.burdastyle.de](http://www.burdastyle.de)

8d



9d

Kontrollquadrat / test square

Seitenlänge / side length

10 cm (4 inches)

v

8e